

Beaumont™

Product Guide 2016



Beaumont has been at the forefront of the design and manufacture of high quality barware for over 30 years

Our new price list includes a comprehensive range of specialist bar tools and design-led products driven by the needs of our customers and our understanding of the current trends in our marketplace.



Contents

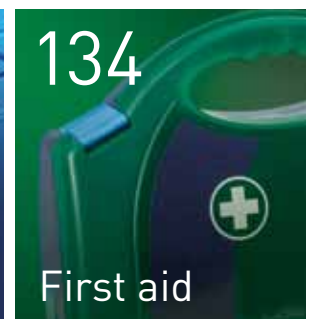
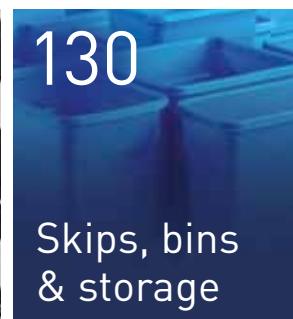
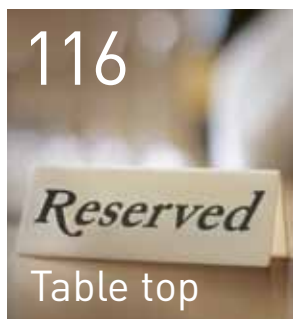
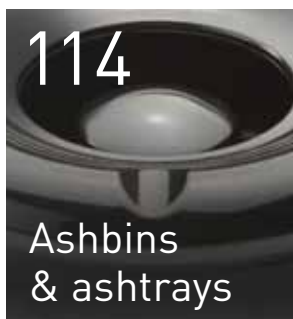
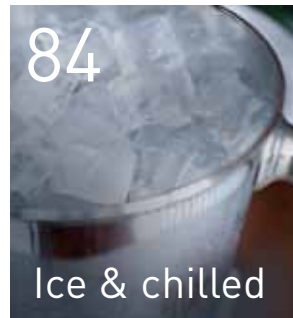
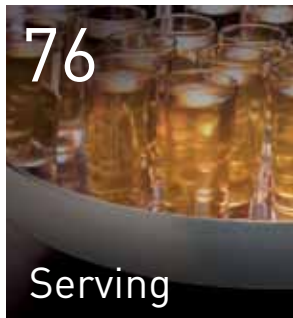
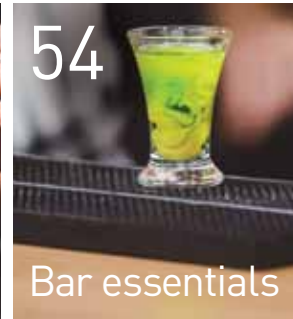
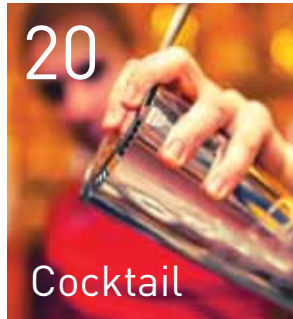

What's new

Mezclar Strainers

Pg 18



**Mezclar Preciso
Multi Measure Jigger**

Pg 19



**Mezclar Banded Jigger
Copper Plated**

Pg 18



Tab Grabbers

Pg 113



Fastflow Pourer

Pg 43



**Julep Strainer
Copper Plated**

Pg 29



**Zester
and Canale
Cutter**

Pg 31



Bar Blade Holster

Pg 82



Nutmeg Grater

Pg 31



What's new

Lemon & Lime Wedger
Pg 63



Copper Spoons
Pg 16



Garnish Tweezers
Pg 31



Bar Mat - Deluxe Black Rubber with Stainless Steel Trim
Pg 57



Cutlery Trays
Pg 112



Silicone Ice Moulds
Pg 35



Rubber Floor Mats
Pg 55

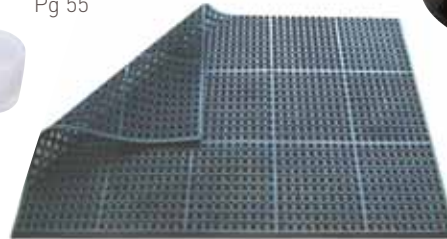

Service Bell 3½'
Pg 112

A close-up photograph of a bartender's hands. The left hand holds a copper cocktail shaker, tilted to pour a vibrant yellow liquid. The right hand holds a fine-mesh metal strainer, catching any solids as the liquid falls into a clear martini glass. The glass is garnished with a delicate, curled slice of lemon. The background is dark with soft, out-of-focus bokeh lights in warm tones.

Mexclar

Hand picked for its quality,
style, sophistication
and elegance

Mezclar



The leading Mixologists from around the world are always looking for stylish and practical tools that will not only enhance the flavours of the cocktails that they produce but will also add to the theatre of their profession. Our Mezclar range has evolved to offer products to help mix, stir, shake and measure the finest cocktails for the discerning bartender.



Mezclar | Art Deco Shaker

Mezclar Art Deco Shaker
Copper Plated

3338
550ml
Ctn 20



Mezclar Art Deco Shaker
Stainless Steel

3337
550ml
Ctn 20



French Shaker | *Mezclar*

Mezclar French Shaker
Stainless Steel

3327
650ml
Ctn 30



Mezclar French Shaker
Copper Plated

3328
600ml
Ctn 16



Mezclar | Mini Shaker

Mezclar Piccolo Mini Shaker
Stainless Steel

3355
600ml
Ctn 48





Copper Can | *Mezclar*

Mezclar Boston Can
Copper Plated

3330
28oz
Ctn 24



Mezclar | Tin on Tin

Mezclar 18oz Boston Can
Stainless Steel

3339
18oz
Ctn 12



Mezclar 18oz and
28oz Boston Can Set

3340
Ctn 12



28oz Boston Can Stainless Steel

3558
28oz
Ctn 12



Boston Can | Water Jug | *Mezclar*

Mezclar Boston Can
Pink Floral

3670PI
28oz
Ctn 90



Mezclar Boston Can
Black Floral

3670BLK
28oz
Ctn 90



Mezclar Jug Stainless Steel

3336
1.5 ltr
Ctn 16



Mezclar | Moscow Mule

Mezclar Moscow Mule Mug
Copper Plated

3329
500ml
Ctn 24



Mezclar Curved Moscow Mule Mug
Copper Plated - Brass Handle

3667
500ml
Ctn 36





Moscow Mule Ingredients

- 50ml vodka
 - 12.5ml lime juice
 - 120ml ginger beer
 - 1 dash bitters
 - Lime peel
-

Moscow Mule Recipe

- Fill the copper mug with crushed ice
- Using a jigger, measure 50ml vodka, 12.5ml lime juice, 120ml ginger beer and one dash of bitters into the mug
- Stir the mixture until well combined
- Garnish with lime peel

Mezclar | Julep Cup

Mezclar Julep Cup Stainless Steel

3666
400ml
Ctn 48



Traditional serving method

Julep Ingredients

- 50ml bourbon
- 10ml ODK Sugar Syrup
- 8 mint leaves
- 2 dashes of Angostura bitters

Julep Recipe

- Add mint and sugar syrup to the cup
- Gently press the mint using a muddler
- Half fill the julep cup with crushed ice. Using a jigger, measure 50ml of bourbon into the cup and add 2 dashes of Angostura bitters
- Stir thoroughly, then add more crushed ice
- Using a bar spoon stir the mixture until well combined, then overfill with more crushed ice
- Add a straw and garnish with mint



Mixing Glass | *Mezclar*

Mezclar Mixing Glass

3921
710ml
Ctn 36



Mezclar | Spoons



Mezclar Hudson Spoon 45cm

3675 Stainless Steel Ctn 200

3677 Copper Plated Ctn 100

NEW



Mezclar Collinson Spoon 45cm

3676 Stainless Steel Ctn 200

3678 Copper Plated Ctn 100

NEW

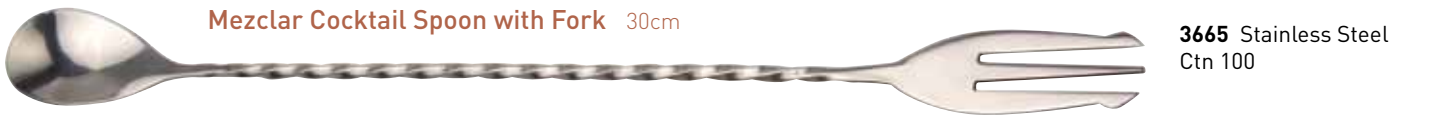

Mezclar Cocktail Spoon with Fork 30cm

3665 Stainless Steel Ctn 100



NEW

3679 Copper Plated Ctn 100



Mezclar | Strainers | Jiggers

Mezclar Strainer
Stainless Steel

3668
Ctn 48

NEW



Mezclar Strainer
Copper Plated

3342
Ctn 48

NEW



Mezclar Banded Jigger
Stainless Steel

3179
25/35/50ml NGS*
Ctn 288

35ml



Mezclar Banded Jigger
Copper Plated

3181
25/35/50ml NGS*
Ctn 288

NEW



Multi Measure Jigger | Mezclar

Mezclar Preciso Multi Measure Jigger
Stainless Steel

3180
NGS*
Ctn 144

NEW



25ml has markings every 5ml



50ml has markings every 10ml



Our cocktail section has
the most comprehensive,
modern and classic tools
to create the perfect drink

Cocktail



Shakers | *Cocktail*

Regular 3 Piece Cocktail Shaker
Stainless Steel

3582
750ml
Ctn 24



Deluxe 3 Piece Cocktail Shaker
Stainless Steel

3583
750ml
Ctn 24



Cocktail | Boston Cans

Orange Powder Coated
Boston Can

3671ORA
28oz
Ctn 12

Yellow Powder Coated
Boston Can

3671YEL
28oz
Ctn 12

White Powder Coated
Boston Can

3671WHI
28oz
Ctn 12

Black Vinyl Coated
Boston Can

3672
28oz
Ctn 48





Boston Cans/Glass | *Cocktail*

Boston Can
Stainless Steel

3558
28oz
Ctn 12

Boston Glass

3559C
16oz
Ctn 24
Sold in multiples of 24

Mini Boston Can
Stainless Steel

3647
16oz
Ctn 12



Cocktail | Muddlers

Wooden Muddler 10"

3578
Ctn 150



Wooden Muddler 8"

3572
Ctn 200



Muddlers | *Cocktail*

Large Wooden
Muddler 13"

3588
Ctn 60



Stainless Steel
& Plastic Muddler 8½"

3655
Ctn 60



Plastic Muddler 8½"

3573
Ctn 48



Cocktail | Flair Bottle

Flair Bottle

3326
Ctn 6



- Simulates empty bottle
- Doesn't break when dropped
- Well balanced
- Strong and durable
- Used by the world's best flair bartenders





Strainer | *Cocktail*

Professional Strainer

3596
Ctn 12



- High quality finish
- Superior spring for finer straining

Cocktail | Strainers

Hawthorne Strainer – 2 Ear

3570
Ctn 12

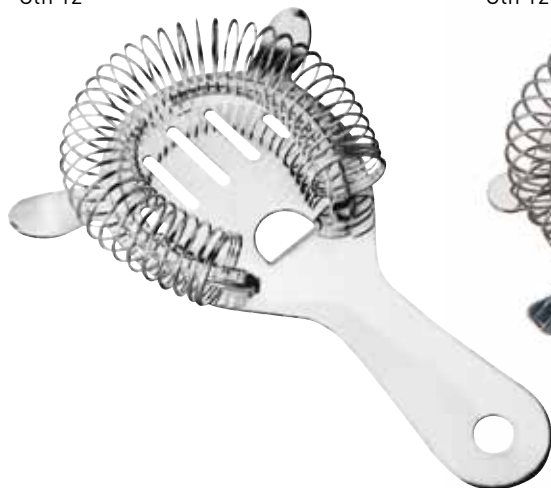

Hawthorne Strainer – 4 Ear

3571
Ctn 12



Fine Mesh Strainer

3730
Ctn 24



Julep Strainer | *Cocktail*

Julep Strainer

3587 Stainless Steel
Ctn 12

3341 Copper Plated
Ctn 12



Cocktail | Spoons

Professional Mixing Spoon

3585

11"

Ctn 24

- 5ml spoon
- Fine twist shaft
- 25mm disc



Cocktail Spoon with Masher

3568

11"

Ctn 40

Cocktail Spoon

3569

12"

Ctn 75





Preparation | *Cocktail*

Nutmeg Grater

3669
Ctn 24

NEW



Zester and
Canale Cutter

3674
Ctn 60

NEW



NEW

Garnish Tweezers

3673
30cm
Ctn 50



Cocktail | Ice Pick | Ice Chipper

Ice Pick

3353
Ctn 12



Ice Chipper

3354
Ctn 12





Ice Moulds | *Cocktail*

6 Section Red Silicone Ice Mould

3350
2" ice cubes
Ctn 54



15 Section Blue Silicone Ice Mould

3349
1 1/4" ice cubes
Ctn 72





Ice Moulds | *Cocktail*

Silicone Ice Shot Glass Mould

3352
Ctn 42

NEW



Silicone Ice Ball Mould

3351
Ctn 48

NEW



Cocktail | Accessories

3 Part Glass Rimmer

3597
Ctn 12



Spare Pad for 3 Part Glass Rimmer

3598
Ctn 12



Chopping Board - White
250mm x 150mm

3694
Ctn 120



Bar Knife

3695
Ctn 144



Ice Crusher

3301
Vacuum Base
Ctn 6



Accessories | *Cocktail*

Speed Rail

3560 22"

Ctn 6

3561 32"

Ctn 6

3562 42"

Ctn 6



Mexican Elbow

- Lemon/Lime Squeezer

3649

Ctn 100



Coco Lopez
Cream of Coconut
- 425g

3348

Ctn 24

Sold in multiples
of 24



Pineapple Slicer & Wedger
- Pk 3

3660

Ctn 6



Cocktail | Scoops

5oz Aluminium Ice Scoop

3641

Ctn 200



12oz Aluminium Ice Scoop

3642

Ctn 200



24oz Aluminium Ice Scoop

3643

Ctn 140



7oz Plastic Drainer Scoop – Clear

3644C

Ctn 100



Stirrers | *Cocktail*

7" Disc Stirrers

Pk 250
Ctn 24

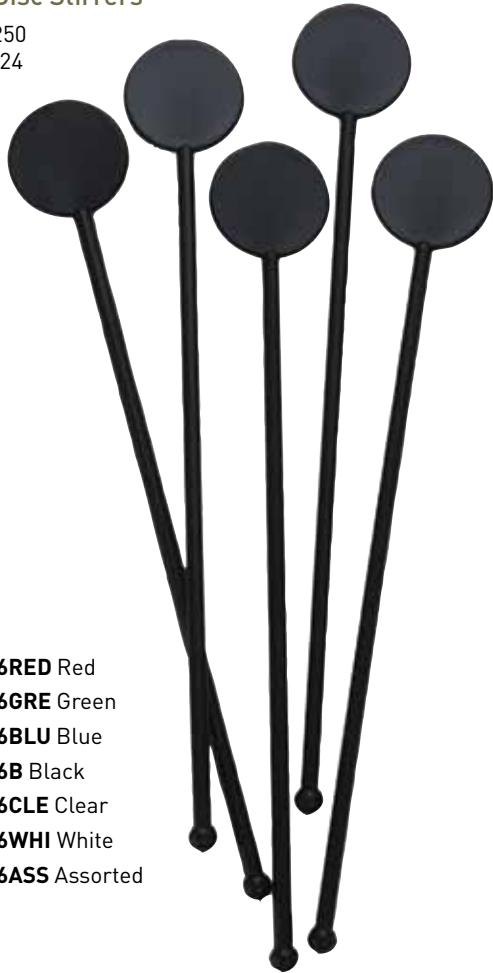

- 3306RED** Red
- 3306GRE** Green
- 3306BLU** Blue
- 3306B** Black
- 3306CLE** Clear
- 3306WHI** White
- 3306ASS** Assorted

6" Disc Stirrers

Pk 250
Ctn 24

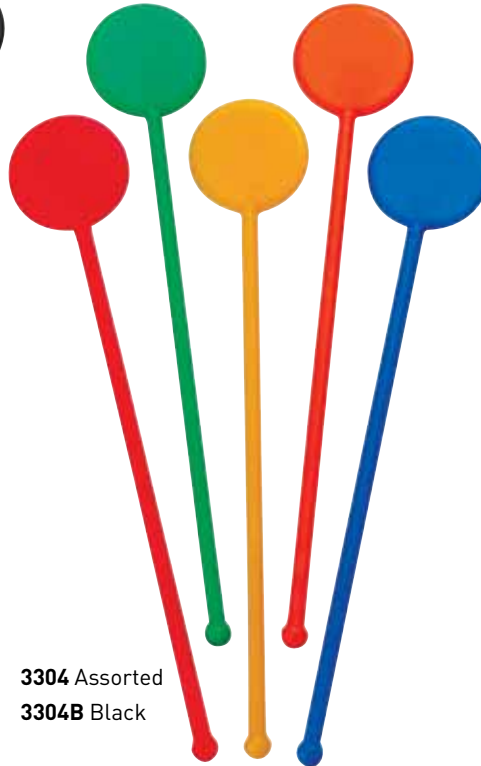

- 3304** Assorted
- 3304B** Black

6" Rod Stirrers - Clear

Pk 1000

3305
Ctn 6



6" Flat Ball Stirrers - Clear

Pk 1000

3310C
Ctn 6



6" Flat Ball Stirrers - Black

Pk 1000

3310B
Ctn 6



Cocktail | Picks | Stirrers

3½" Red Prism Pick
- Box 1000

3308R
Ctn 12



3½" Clear Prism Pick
- Box 1000

3308C
Ctn 12



3½" Assorted Prism Pick
- Box 1000

3308ASS
Ctn 12



3½" Black Prism Pick
- Box 1000

3308B
Ctn 12



7" Assorted Prism Stirrer
- Box 1000

3309ASS
Ctn 6



7" Black Prism Stirrer
- Box 1000

3309B
Ctn 6



7" Clear Prism Stirrer
- Box 1000

3309C
Ctn 6



Stirrers | Picks | Parasols | *Cocktail*

6½" Clear Swirl Stirrer
- Box 1000

3311C
Ctn 1



6½" Black Swirl Stirrer
- Box 1000

3311B
Ctn 1



3½" Clear Swirl Pick
- Box 1000

3312C
Ctn 1



3½" Black Swirl Pick
- Box 1000

3312B
Ctn 1



Wooden Cocktail Sticks
- Pk 1000

3316
Ctn 100

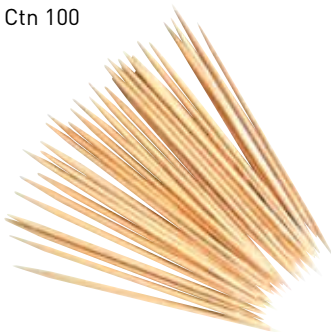

Paper Wrapped Wooden
Toothpick
- Pk 1000

3314
Ctn 50



Cocktail Parasols
- Pk 144

3315
Ctn 100



A close-up photograph of a bartender's hands, heavily tattooed, using a metal pourer to dispense a golden liquid into a glass. The bartender is wearing a grey beanie and a dark shirt. The background is blurred, showing a bar setting with various bottles and lights.

Pouring

This section covers a variety of pourers for your bartending needs. From simple economy plastic free flows to the new Cap-On Pourer and of course the TD105-30

Freeflow | Fastflow | Pro Pour | *Pouring*

Freeflow Pouter Stainless Steel

3041P
Ctn 50

Sold in multiples
of 10



Fastflow Pouter Stainless Steel

3040P
Ctn 40

Sold in multiples
of 12

NEW



Pro Pour

3916
Ctn 56

- Professional training aid to test free pouring skills
- Measures in Ml and Oz



Pourer Cap - Pk 12

3061
Ctn 48

- Fits standard metal pourers and fast flow pourers



Pouring | TD105-30



Tom Dyer has been involved in almost every major flair competition in the world for the past 15 years and is also renowned for his professional bartending skills, having learned early in his career that it is important to bartend first and flair second. Tom has trained bartenders all over the world, working with the likes of Diageo and Red Bull, opening bars and performing shows, or simply coming up with new cocktails on his travels.

tomdyer TD105-30

Chrome Freeflow Pourer

3515PTD
Ctn 40

Sold in multiples
of 12



- The most consistent, accurate and durable pour spout on the market
- Used in the most famous bars in the world
- Sold in over 32 countries
- Used in 100's of bar schools
- Designed, tested and endorsed by Tom Dyer

*Seen in the best bars
all over the world →*







tomdyer

Tom now has four bartending schools with the European Bartender School, his own pour spout (the best-selling pour spout in the world), an importing company and is one of the Co-founders and WFA Grading Co-ordinator for the World Flair Association. Twelve times UK champion, multiple world champion and twice Guinness World Record Holder, Tom decided it was time to quit competing in flair and focus on improving training standards in flair bartending and competitions through the World Flair Association and EBS.

Pouring | Freeflow | Cap-On | Aquaflow

Red Economy Freeflow Plastic Pourer

3060AP
Ctn 60

Sold in multiples of 10



Black Economy Freeflow Plastic Pourer

3060BP
Ctn 60

Sold in multiples of 10



Translucent Economy Freeflow Plastic Pourer

3060CP
Ctn 60

Sold in multiples of 10



Aquaflow Pourer

Ctn 200

3047 25NGS*

3048 35NGS*

3049 50NGS*

- Measured pourer, dispenses and refills time after time without having to tip the bottle back
- Chrome plated

*NGS = Not Government Stamped
Must be used in conjunction with an approved Thimble Measure for the prescribed spirits – whisky, gin, vodka and rum.



Short Plastic/Chrome Freeflow Pourer

3516P
Ctn 60

Sold in multiples of 10



Cap-On Pourer Pk 12

3062
Ctn 48

- Convenient, disposable, medium flow pourer
- Hygienic – allows bottle to be resealed with cap after each serving



Quick Shot | *Pouring*

Freeflow Quick Shot Poured - Clear

3024
Ctn 30

Sold in multiples
of 12



Quick Shot Poured

Ctn 30

Sold in multiples
of 12

- Standard 3-ball pourer – dispenses like a freeflow but gives a controlled measure
- Also available in CL sizes



3030 25 NGS* Red
3055A 25 NGS* Clear



3029 35 NGS* Clear



3031 50 NGS* Blue
3046 50 NGS* Clear

Instructions For Use

Prime the pourer by holding a finger over the spout and quickly turning the bottle over. Prime pourer before the first use and after each cleaning. If the pourers are not primed, the first shot may not be measured accurately.

When pouring, turn the bottle in a smooth motion to a 45-60 degree angle. Shot pourers are designed to pour fast.

*NGS = Not Government Stamped

Must be used in conjunction with an approved Thimble Measure for the prescribed spirits – whisky, gin, vodka and rum.

Pouring | Sure Shot | Collarless Quick Shot

Sure Shot Pourer

Ctn 60

Sold in multiples of 12



- Superior American 3-ball pourer – dispenses like a freeflow but gives a controlled measure

Collarless Quick Shot Pourer

- Clear

Ctn 1

Sold in multiples of 12

3697 25NGS*

3698 35NGS*

3699 50NGS*

*NGS = Not Government Stamped



3020 25 NGS* Clear



3028 35 NGS* Clear



3026 50 NGS* Blue



Instructions For Use

Prime the pourer by holding a finger over the spout and quickly turning the bottle over. Prime pourer before the first use and after each cleaning. If the pourers are not primed, the first shot may not be measured accurately.

When pouring, turn the bottle in a smooth motion to a 45-60 degree angle. Shot pourers are designed to pour fast.

*NGS = Not Government Stamped

Must be used in conjunction with an approved Thimble Measure for the prescribed spirits – whisky, gin, vodka and rum.

Save & Pour | *Pouring*



Save & Pour Quart
Ctn 12

Save & Pour Spout
- Clear
3322C
Ctn 12



Save & Pour Lid
- White
3323W
Ctn 12



3321BR Brown

3321G Green

3321O Orange

3321R Red

3321W White

3321Y Yellow

Pouring | Save & Pour Professional



Save & Pour Professional Quart
Ctn 12

Save & Pour Professional Spout
- Clear

3325C
Ctn 12



Save & Pour Professional Lid
- White

3323W
Ctn 12



3324G Green



3324O Orange



3324R Red



3324W White



3324Y Yellow

Freepour Bottle™ | *Pouring*



Freepour Bottle™
1 ltr capacity
Ctn 12

- Consistent flow, no 'glug'
- 3 piece design
- Holds 1 litre



33200 Orange



3320R Red



3320B Blue



3320Y Yellow



3320W White



3320G Green

The background of the image shows two glasses of a vibrant green beverage, possibly a cocktail or smoothie, served on a black bar tray. The glasses are positioned on the left and right sides of the frame. The text 'Bar essentials' is overlaid in a large, white, cursive font across the center of the image.

Bar essentials

Our range of bar essentials
offers a variety of items
for storage, serving and
displaying your drink

Floor Mats | *Bar essentials*



Rubber Interlocking Floor Mat

3683

90cm x 90cm x 1.2cm

Ctn 1

NEW



Rubber Bevelled Edge Floor Mat

3684

150cm x 90cm x 1.2cm

Ctn 1

NEW

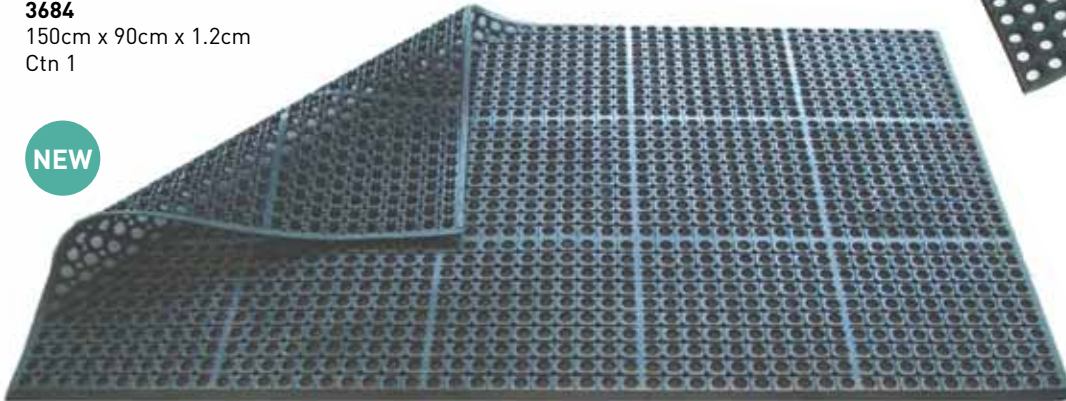

Bar essentials | Bar Mats

Bar Mat – Deluxe Black Rubber

3620

610mm x 80mm/24" x 3"

Ctn 12



- High grade rubber
- Strong and durable
- Holds its shape - doesn't disfigure or warp



Bar Mats | *Bar essentials*

Bar Mat – Deluxe Black Rubber with Stainless Steel Trim

3626

608mm x 100mm/24" x 4"

Ctn 20

NEW



Bar Mat – Black Rubber

3625

450mm x 300mm/18" x 12"

Ctn 12

Bar essentials | Wooden Drip Tray

Wooden Drip Tray

3579

600mm x 220mm/24" x 9"

Ctn 1



- Made from treated beech
- Supplied with rubber feet to prevent bar top scratches



Drip Trays | *Bar essentials*

Stainless Steel Drip Tray

3503

305mm x 152mm/12" x 6"

Ctn 24

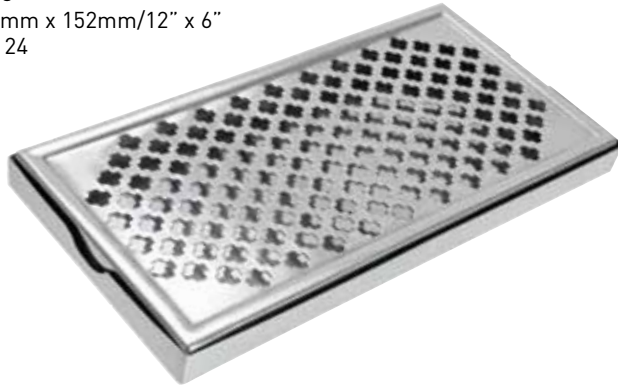

Stainless Steel Round Drip Tray

3507

152mm/6" diameter

Ctn 12



Brass Effect Drip Tray

3557A

406mm x 222mm/16" x 8¾"

Ctn 20



Aluminium Effect Drip Tray

3648

406mm x 222mm/16" x 8¾"

Ctn 20



Bar essentials | Glass Mats/Tile

Interlocking Glass Mats – Pk 10
– 205mm x 305mm

B14
Ctn 25



Interlocking Glass Mats Heavy Duty – Pk 10
– 324mm x 216mm

B14C
Ctn 20



Interlocking Bar Shelf Tile
– Black 13” x 13”

3915B
Ctn 12

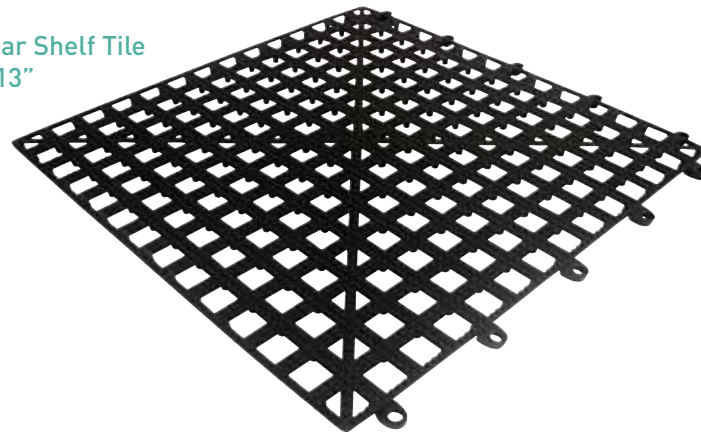

Shelf Liner | *Bar essentials*

Shelf Liner – Black
– 61cm x 10m

3685BLK
Ctn 1



Shelf Liner – Clear
– 61cm x 10m

3685CL
Ctn 1



Shelf Liner – Green
– 61cm x 10m

3685GR
Ctn 1



Shelf Liner – Red
– 61cm x 10m

3685RE
Ctn 1

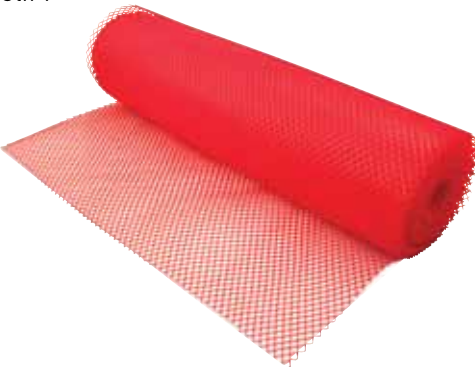

Shelf Liner – White
– 61cm x 10m

3685WH
Ctn 1



Shelf Liner – Clear
– 61cm x 5m

3556
Ctn 4



Bar essentials | Glass Carrier/Washer

Glass Carrier
– Green

3910G
Ctn 6



3 Brush Glass Washer

3521
Ctn 12



5 Brush Glass Washer

3519
Ctn 24



Lemon & Lime Wedger | *Bar essentials*

Lemon & Lime Wedger

3659
Ctn 8



NEW



- Perfectly sliced wedges
- Fast and convenient
- Slices 8 wedges in one go
- Easy to clean
- Heavy duty, robust

Bar essentials | Bar Caddies

Bar Caddy – White

3535WHI
Ctn 12



Bar Caddy – Orange

3535ORA
Ctn 12

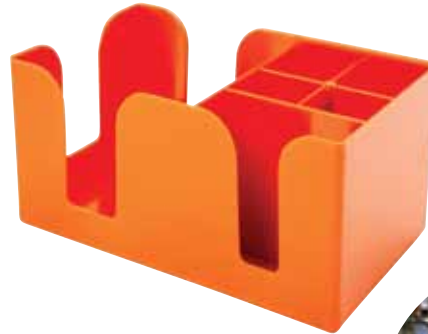

Bar Caddy – Yellow

3535YEL
Ctn 12

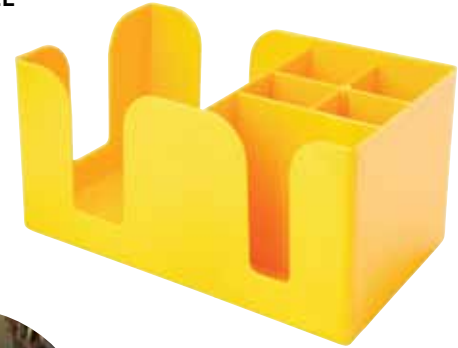

Bar Caddy – Black

3535
Ctn 12



Bar Caddy – Wooden

3542
Ctn 12



Bar Caddy – Chrome Plated

3535CHR
Ctn 12



Condiment Holders | *Bar essentials*

Plastic Condiment Holder
4 Compartments x 1 pint

3765
Ctn 6



Plastic Condiment Holder
6 Compartments x 1 pint

3766
Ctn 6



Plastic Bar Centre
4 Compartments x 1 pint

3767
Ctn 6



Stainless Steel
Condiment Holder
4 Compartments x 1 pint

3761
Ctn 25



Stainless Steel
Condiment Holder
5 Compartments x 1 pint

3762
Ctn 15



Stainless Steel
Condiment Holder
6 Compartments x 1 pint

3763
Ctn 15



Spare Insert for
Condiment Holders

3764
Ctn 72



Bar essentials | Glass Hangers

Glass Hanger 10"
Brass

3691BR
Ctn 12



Glass Hanger 16"
Brass

3692BR
Ctn 12



Glass Hanger 24"
Brass

3693BR
Ctn 12



Glass Hanger 10"
Chrome

3691CHR
Ctn 12



Glass Hanger 16"
Chrome

3692CHR
Ctn 12



Glass Hanger 24"
Chrome

3693CHR
Ctn 12

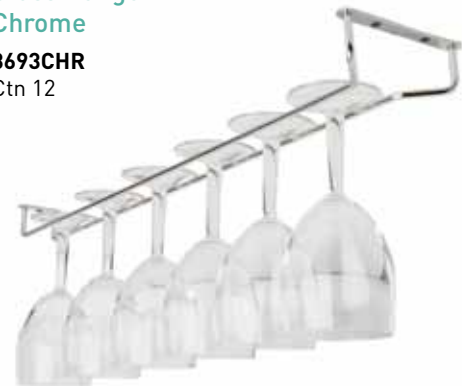

Glasses not included

Tip Trays | Spindles | *Bar essentials*

Stainless Steel Tip Tray

3529
Ctn 24



Black Plastic Tip Tray with Clip

3595
Ctn 12



6½" Brass Cheque Spindle

3661BR
Ctn 12



6½" Chrome Cheque Spindle

3661CHR
Ctn 12



Black Plastic Tip Tray - Plain

3589
Ctn 12



Black Plastic Tip Tray - Thank You

3590
Ctn 12



A close-up photograph of a highly reflective stainless steel champagne cooler. The cooler is filled with several lemons and limes. The background is blurred, showing other similar coolers in a kitchen setting. The lighting is warm, highlighting the metallic sheen of the cooler and the vibrant colors of the fruit.

SIGNATURE

CHAMPAGNE & WINE COOLERS

The Signature range encompasses design and functionality.

Made from high grade stainless steel, our coolers offer a sophisticated yet affordable way to cool your drinks.

Ice Bucket | SIGNATURE

Taille Ice Bucket Hammered Finish

9000

18cm (H) x 17cm (D) x 13cm (int Ø)

750g

Ctn 12



SIGNATURE | Coolers

Fresco Wine/Champagne Cooler Polished Finish

9020

21cm (H) x 19cm (D) x 16cm (int Ø)

500g

Ctn 6



Obella Wine/Champagne Cooler Polished Finish

9021

19cm (H) x 14cm (D) x 10.5cm (int Ø)

450g

Ctn 12



Coolers | SIGNATURE

Bolalto Wine Cooler Hammered Finish

9010

19cm (H) x 14cm (D) x 11cm (int Ø)

600g

Ctn 12



Bolargo Wine/Champagne Cooler Hammered Finish

9011

20cm (H) x 20cm (D) x 14cm (int Ø)

1200g

Ctn 6





Bowl Coolers | SIGNATURE

Bellagio Wine/Champagne Cooler Hammered Finish

9030

24cm (H) x 16cm (D int) x 38cm (Ø int) x 43cm (Ø ext)

2.4kg

Ctn 2



Bollate Wine/Champagne Cooler Hammered Finish

9031

20cm (H) x 16cm (D int) x 33cm (Ø)

750g

Ctn 4



SIGNATURE | Coolers

Secchio Wine and Champagne Cooler

9055

27cm (H) x 44cm (Ø)

3.2kg

Ctn 2



Ciro Wine/Champagne Cooler Polished Finish

9045

18cm (H) x 13cm (W) x 27.5cm (L) x 35cm (ext L)

1.5kg

Ctn 4



Stand Coolers | SIGNATURE

Classique Wine/Champagne Bucket & Stand

9050

81cm (H) x 21cm (Ø bucket)

Polished Finish

3kg

Ctn 2

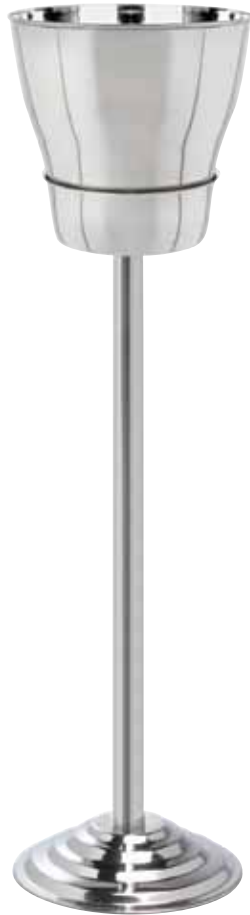

Voltre Wine/Champagne Bucket & Stand

9051

103cm (H) x 23cm (Ø bucket)

Hammered Finish

3kg

Ctn 2



Serving



Non-Slip Trays | *Serving*

Non-Slip Black Tray Brushed Aluminium Effect

3517

330mm diameter

Ctn 10

- Super rubber non-slip surface



14" x 18" Rectangular Non-Slip Tray

3681

Ctn 12



15" x 20" Rectangular Non-Slip Tray

3682

Ctn 12



Serving | Non-Slip Trays

11" Round Black Non-Slip Tray

3591
Ctn 12



14" Round Black Non-Slip Tray

3592
Ctn 12



16" Round Black Non-Slip Tray

3593
Ctn 12



27" x 22" Oval Black Non-Slip Tray

3594
Ctn 6



Anti-Slip Tray Mat | *Serving*



Anti-Slip Mat

3651 to fit 11" Tray
Ctn 12

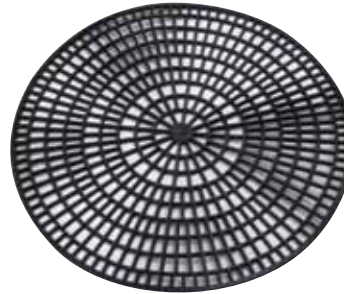

3652 to fit 14" Tray
Ctn 12

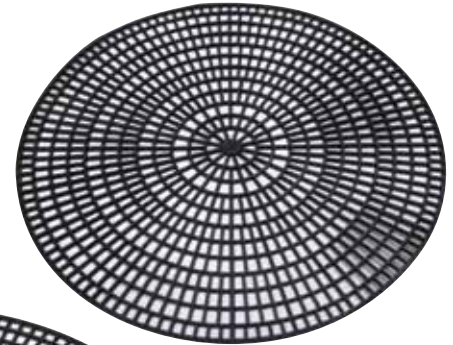

3653 to fit 16" Tray
Ctn 12

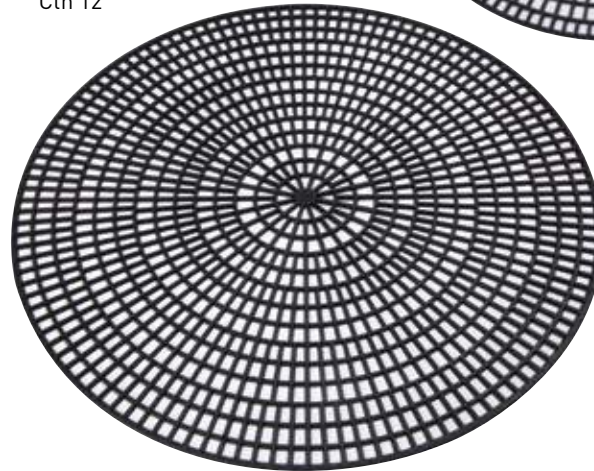

A close-up, high-contrast photograph of a mechanical assembly, likely a watch movement. The central focus is a vertical shaft with several cylindrical components, possibly gears or bearings, stacked on it. The shaft is flanked by two large, curved metal plates that form a frame or support structure. The lighting is dramatic, highlighting the metallic surfaces and creating deep shadows. The overall aesthetic is industrial and precise.

*Openers
& sealers*

Openers & sealers

Twin Lever Corkscrew

3528
Ctn 24



Double-Reach Corkscrew

3534
Ctn 12



Stainless Steel Waiter's Friend

3490
Ctn 24



Waiter's Friend Bottle Opener

3520
Ctn 20



Bottle Opener (inc. foil cutter)

3518A
Ctn 10



Openers & sealers

Economy Bottle Opener

3584
Ctn 100



Under Counter Opener
& Catcher

3540
Ctn 15



Wine Bottle Re-Sealers – Pk 10

3513
Ctn 100



7" Bar Blade

3536
Ctn 24



7" Bar Blade
Vinyl Coated Black

3536B
Ctn 144



Bar Blade
Holster

3536H
Ctn 1

▪ Real Leather



NEW



Openers & sealers

Stand-Up Bottle Opener & Catcher

3522
Ctn 16



Opener Only

3523
Ctn 200



Catcher Only

3524
Ctn 36



▪ Suitable for 3524 & 3540

Vacu Vin Wine Pump Inc. 2 x Sealers

8121
Ctn 6



Vacu Vin Sealers – Pk 2

8405
Ctn 12



Champagne Stopper

3539
Ctn 50





*Ice
& chilled*

Coolers | *Ice & chilled*

Aluminium Bar Cooler Tub

3510

29.2cm (Ø) x 16.5cm (H)

Ctn 4



Stainless Steel Wine Cooler

3533

12cm (Ø ext) x 20cm (H)

Ctn 24



Chrome & Plastic Wine Cooler

3506

11.5cm (Ø ext) x 22.7cm (H)

Ctn 12



Ice & chilled | Buckets

Aluminium Champagne Bucket

3508
4 litre/7 pint
Ctn 4



Stainless Steel Champagne Bucket

3512
5 litre
Ctn 6



Stainless Steel Tulip Ice Bucket

3496
4.5 litre
Ctn 6



Bucket Stands | *Ice & chilled*

Stainless Steel Space Saver (Folding) Bucket Stand

3500
Ctn 1

- **Folds easily
for storage**

Suitable for:
Aluminium Champagne Bucket (3508)
Stainless Steel Champagne Bucket (3512)
Stainless Steel Tulip Ice Bucket (3496)



Traditional Champagne Bucket Stand

3509
Ctn 1

Suitable for:
Aluminium Champagne Bucket (3508)
Stainless Steel Champagne Bucket (3512)
Stainless Steel Tulip Ice Bucket (3496)

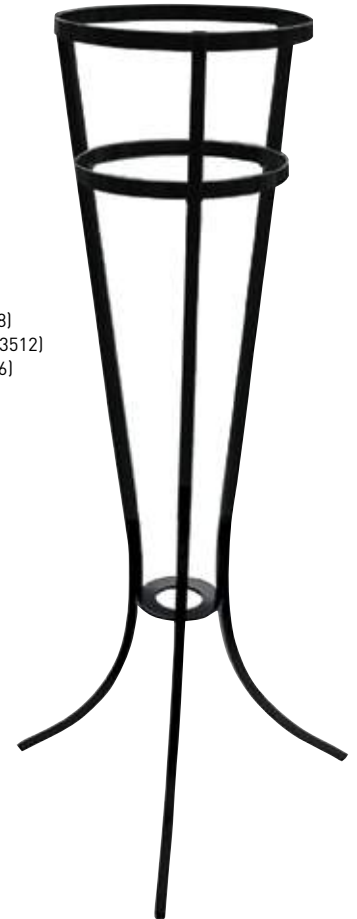

Ice & chilled | Buckets | Tongs | Tubs

Square Ice Bucket – Black

3501

5 litre/8.8 pint
190mm x 190mm x 200mm (H)
Ctn 1



Round Ice Bucket – Black

3502

4 litre/7 pint
200mm (Ø) x 200mm (H)
Ctn 1



Plastic Ice Bucket Brushed – Aluminium Effect

3495

10 litre
292mm (Ø) x 217mm (H)
Ctn 4



7" Stainless Steel Ice Tongs

3586

Ctn 288



Barrel End Ice Tub – Wood Grain

MCN103

11 litre/19 pint
330mm (Ø) x 176mm (H)
Ctn 1



Half Barrel End Ice Tub – Wood Grain

MCN106

7 litre/12 pint
327mm (Ø) x 176mm (H)
Ctn 1



Tub | *Ice & chilled*

Galvanised Steel Beverage Tub

3505

25 litre

49cm (L) x 36.5cm (W) x 22cm (H)

Ctn 3



Care Instructions:

If water is left in this item for periods any longer than 6 hours staining and/or corrosion may start to occur.

Dry thoroughly after every use with a clean cloth.

Clean with a soft cloth dampened in water and a mild non-abrasive washing-up detergent or soap. Rinse and dry thoroughly after cleaning.

Store in a dry environment.



Dispensing

For over 30 years Beaumont has been recognised as the favoured choice by publicans for Spirit Measures. With the collaborations of our distributors and point of sale representatives Beaumont has become the number one manufacturer in the world.

Obviously, we don't want to give away all of our trade secrets but we are happy to let you know that the quality, longevity and accuracy of our Spirit Measures is no accident; our industry knowledge, together with the use of the highest quality materials and proven manufacturing techniques, ensures that we maintain the edge over every other manufacturer.

Vogue | *Dispensing*

Vogue Spirit Measure

3080 25ml

3081 35ml

3082 50ml

3083 35.5ml NGS*

3083V 35.5ml

Verified for use in Eire

Ctn 100

*NGS = Not Government Stamped



- Reliable non-drip mechanism
- Hygienic – can be operated using the rim of the glass
- Smooth dispense action
- Single handed operation
- Revolutionary design
- Distinctive, premium and eye catching
- Also available in CL and US oz sizes
- See page 96 for cork options
- See pages 101-105 for bracket options

Dispensing | Metrix SL

Metrix SL Spirit Measure

3134 25ml

3135 35ml

3139 50ml

3141 35.5ml NGS*

3141V 35.5ml

Verified for use in Eire

Ctn 100

*NGS = Not Government Stamped



- The UK's preferred premium measure
- Reliable non-drip mechanism
- Hygienic – designed to be operated using the rim of the glass
- Smooth dispense action
- Single handed operation
- Also available in CL and US oz sizes
- See page 96 for cork options
- See pages 101-105 for bracket options

Solo | *Dispensing*

Solo Classical Measure

3103 25ml

3066 35ml

3104 50ml

3113 35.5ml NGS*

3113V 35.5ml

Verified for use in Eire

3105 Freeflow Solo Classical NGS*

3105L Freeflow Solo Classical

Long Spindle NGS*

Designed for use with wine cabinets

Ctn 100

*NGS = Not Government Stamped



- Over 6 million units sold in the UK
- Proven reliability
- Cost-effective solution
- Reliable non-drip mechanism
- Smooth dispense action
- Also available in CL and US oz sizes
- See page 96 for cork options
- See pages 101-105 for bracket options

Dispensing | Solo

Solo Classical Chrome Measures

3098 25ml

3074 35ml

3099 50ml

3114 35.5ml NGS*

3114V 35.5ml

Verified for use in Eire

Ctn 75

*NGS = Not Government Stamped

- Chrome plated metal headplate
- Designed for use with heavier bottles
- Proven reliability
- Cost-effective solution
- Reliable non-drip mechanism
- Smooth dispense action
- Also available in CL and US oz sizes
- See page 96 for cork options
- See pages 101-105 for bracket options



Solo Professional Measures

3103P 25ml

3066P 35ml

3104P 50ml

Ctn 100

- Smooth push-back lever action
- Also available in CL and US oz sizes



Solo | *Dispensing*

Solo Counter Measures

- 3103C** 25ml
- 3066C** 35ml
- 3104C** 50ml
- 3113C** 35.5ml NGS*
- 3113CV** 35.5ml
Verified for use in Eire

Ctn 100

*NGS = Not Government Stamped

- Control your costs with our counter measure - don't lose your profit!
- Also available in CL and US oz sizes
- See page 96 for cork options
- See pages 101-105 for bracket options



Solo Wine Measures

- 3136** 125ml
- 3137** 125ml
Long spindle*

Ctn 60

- *Designed for use with wine cabinets



Solo Aniseed Measure

- 3110** 25ml NGS*

Ctn 60

- Fitted with a metal spindle for use with aniseed based drinks
- Also available in CL and US oz sizes



Dispensing | Corks | Spirit Measure Cleaner

Standard Black Solid Rubber Corks – Pk 20

Suitable for 70cl to 1.5L bottles

3546P
Ctn 100



Standard Finned Corks – Pk 20

Suitable for 70cl to 1.5L bottles

3555P
Ctn 100



Half Gallon Finned Corks – Pk 10

3548FP
Ctn 100



Gallon Finned Corks – Pk 10

3550FP
Ctn 100



Standard Natural Corks – Pk 25

Suitable for 70cl to 1.5L bottles

3544P
Ctn 100



Half Gallon Natural Corks – Pk 10

3547
Ctn 100



Gallon Natural Corks – Pk 10

3549
Ctn 100



Spirit Measure Cleaner 1 litre/33oz – Pk 6

2524
Ctn 1



Thimble Measures | Jiggers | *Dispensing*

Thimble Measures - CE Marked

- | | |
|--------------------------------|------------------------------|
| 3175 25ml
Ctn 48 | 3191 175ml
Ctn 100 |
| 3189 35ml
Ctn 24 | 3194 200ml
Ctn 100 |
| 3188SV 35.5ml
Ctn 24 | 3193 250ml
Ctn 100 |
| 3176 50ml
Ctn 24 | 3195 2cl
Ctn 48 |
| 3173 70ml
Ctn 24 | 3161 3cl
Ctn 24 |
| 3174SV 71ml
Ctn 24 | 3163 4cl
Ctn 24 |
| 3183 100ml
Ctn 100 | 3164 5cl
Ctn 24 |
| 3190 125ml
Ctn 100 | |



Professional
25ml/50ml Cocktail
Jigger NGS*

3178
Ctn 12

*NGS = Not Government Stamped



Classic UK 25ml/50ml
CE Marked Jigger

3185
Ctn 24



■ Manufactured from high grade stainless steel



Clips | *Dispensing*

Shot Clip

3197

Chrome – Pk 5
Ctn 100



- Allows a Thimble Measure to be dedicated to each bottle
- Stops cross-contamination
- Saves time

Identi-clip

3151RED Large – Red

3151WHI Large – White

3151ROSE Large – Rosé

Ctn 50



- The perfect solution for Thimble Measure identification
- No more cross-contamination
- Stylish, easy clip-on, easy to clean stainless steel

Dispensing | Shot Rails

Shot Rail (holds 2 measures)

3198
Ctn 48



Shot Rail (holds 4 measures)

3199
Ctn 48



*Thimble Measures not included with products on this page.

Wall & Shelf Brackets | *Dispensing*



Shelf Bracket

70cl/1 litre

3201

Ctn 100

1.5 litre/40oz

3203

Ctn 100



Wall Bracket

70cl/1 litre

3202

Ctn 150

1.5 litre/40oz

3204

Ctn 150

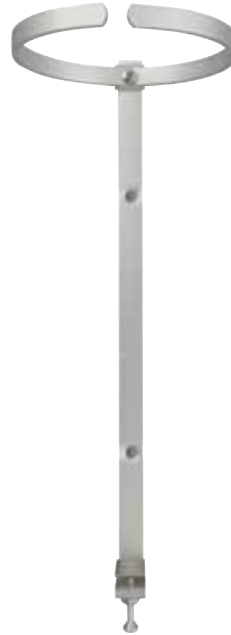

Round Bracket

Wall ½ Gallon

3205

Ctn 50

Wall 1 Gallon
/4.5 litre

3207

Ctn 50



Square Bracket

Wall ½ Gallon

3206

Ctn 50

Wall 1 Gallon
/4.5 litre

3208

Ctn 50



Euro Adaptor

For use with non-refillable bottles

3000

Ctn 100

**Euro Adaptor Shelf Bracket
(70cl/1 litre)**

For use with Euro Adaptor above

3265

Ctn 100

**Euro Adaptor Wall Bracket
(70cl/1 litre)**

For use with Euro Adaptor above

3239

Ctn 150

Dispensing | Bottle Racks

Standard Bottle Racks



Description	Code	Ctn
Wall 2 Bottle Rack (70cl/1 litre)	3209	1
Wall 3 Bottle Rack (70cl/1 litre)	3211	1
Wall 4 Bottle Rack (70cl/1 litre)	3213	1
Wall 5 Bottle Rack (70cl/1 litre)	3215	8
Wall 6 Bottle Rack (70cl/1 litre)	3217	8
Wall 3 Bottle Rack (1.5 litre/40oz)	3211A	1
Wall 4 Bottle Rack (1.5 litre/40oz)	3213A	1
Wall 6 Bottle Rack (1.5 litre/40oz)	3217B	8

Staggered Bottle Racks



Description	Code	Ctn
Staggered Wall 3 Bottle Rack (70cl/1 litre)	3267	6
Staggered Wall 5 Bottle Rack (70cl/1 litre)	3218A	4
Staggered Wall 7 Bottle Rack (70cl/1 litre)	3218B	5
Staggered Wall 9 Bottle Rack (70cl/1 litre)	3218C	5
Staggered Wall 11 Bottle Rack (70cl/1 litre)	3218D	5

Bottle Stands | *Dispensing*

Fixed Bottle Stands



Description	Code	Ctn
Single Pillar Fixed 2 Bottle Stand (70cl/1 litre)	3220	1
Single Pillar Fixed 4 Bottle Stand (70cl/1 litre)	3221	1
Twin Pillar Fixed 6 Bottle Stand (70cl/1 litre)	3222	1
Twin Pillar Fixed 6 Bottle Stand (1.5 litre/40oz)	3222C	1

Portable Bottle Stands



Description	Code	Ctn
Single Pillar Portable 4 Bottle Stand (70cl/1 litre)	3224	1
Single Pillar Portable 4 Bottle Stand - Heavy Base (70cl/1 litre)	3225	1
Single Pillar Portable 6 Bottle Stand (70cl/1 litre)	3228	1
Single Pillar Portable 6 Bottle Stand - Heavy Base (70cl/1 litre)	3229	1

Dispensing | Rotary Bottle Stands

Rotary Bottle Stands

Description	Code	Ctn
Rotary 4 Bottle Stand (70cl/1 litre)	3230	5
Rotary 4 Bottle Stand – Heavy Base (70cl/1 litre)	3231	5
Rotary 4 Bottle Stand – Heavy Base (1.5 litre/40oz)	3231A	5
Rotary 6 Bottle Stand (70cl/1 litre)	3233	5
Rotary 6 Bottle Stand – Heavy Base (70cl/1 litre)	3234	5
Rotary 6 Bottle Stand – Heavy Base (1.5 litre/40oz)	3234A	5



Rotary Bottle Stands | *Dispensing*

Rotary Bottle Stands (Shelf or Wall Mounted)

Description	Code	Ctn
Rotary 4 – Shelf Mounted (70cl/1 litre)	3236	4
Rotary 4 – Wall Mounted (70cl/1 litre)	3236W	4
Rotary 6 – Shelf Mounted (70cl/1 litre)	3237	4
Rotary 6 – Wall Mounted (70cl/1 litre)	3237W	4



Celebrating 35 years of giving
real ale the tap it deserves

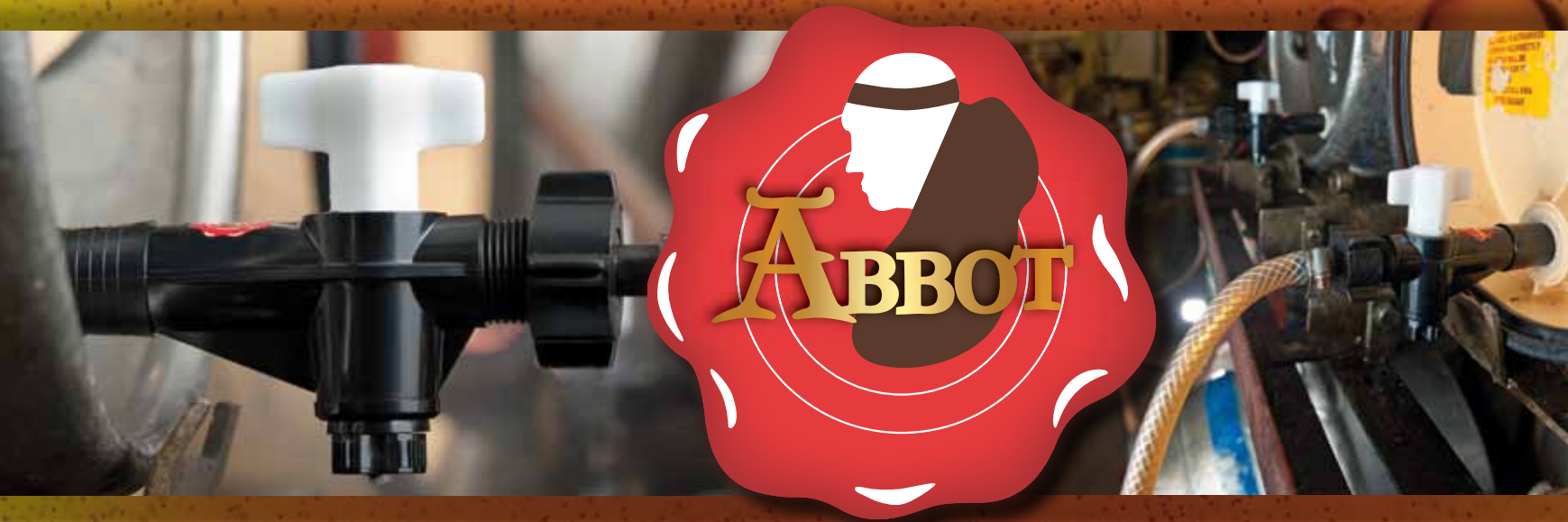

As specified by the UK's largest breweries

Cellar Cask Taps | *Dispensing*



Cask Taps

Abbot Single Plastic Tap

Thread Type	Code	Ctn
'L' Thread	3601	100
'Y' Thread	3602	100
3/4" BSP Thread	3603	100

Abbot Double Plastic Tap

Thread Type	Code	Ctn
'L' Thread	3605	50
'Y' Thread	3606	50
3/4" BSP Thread	3607	50

- Smooth opening and closing action
- Strong design, no leaks
- Preferred choice for breweries



Dispensing | Cellar

Hose Tail

Size (hose diameter)	Code	Ctn
3/8" for Standard Tap (Y&L)	3609	50
1/2" for Standard Tap (Y&L)	3609A	50
5/8" for Standard Tap (Y&L)	3609B	50
1/2" for 3/4" BSP Tap	3609C	50
3/8" for 3/4" BSP Tap	3609D	50



Hop Strainer

Description	Code	Ctn
Standard - Pk 100	3612	1
Standard - Pk 10	3612A	10
3/4" BSP - Pk 100	3613	1
3/4" BSP - Pk 10	3613A	10



Turn Down Spout

Description	Code	Ctn
Standard 1/2" O/D	3617	50
3/4" BSP 1/2" O/D	3617BSP	50

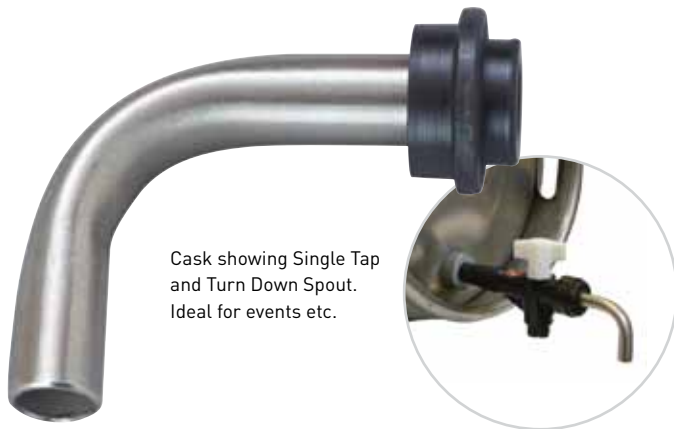

Cask showing Single Tap and Turn Down Spout. Ideal for events etc.

Brewery Nut

Thread type	Code	Ctn
'L' Thread	3610	50
'Y' Thread	3610A	50
3/4" BSP Thread	3610B	50



Please note the BSP Nut does not have a marking

Cellar | *Dispensing*

38mm Cane Porous Spile

Pk 50

3622

Ctn 200



58mm Hardwood Spile

Pk 50

3623

Ctn 100



32oz Rubber Mallet

3619

Ctn 1



Tap Brush

3624

Ctn 25



Sparkler

3627

Ctn 50





*Food
service*

Buckets | Cups | Tub | *Food service*

Appetiser Serving Bucket

3951
7cm x 5cm
Ctn 12



Appetiser Serving Bucket

3952
10.5cm x 10cm
Ctn 12



Galvanised Serving Bucket*

3956
10.5cm x 10.5cm
Ctn 12



Appetiser Hammered Cup

3954
8.5cm x 8.5 cm
Ctn 24



Appetiser Polished Cup

3955
8.5cm x 8.5cm
Ctn 24



Galvanised Serving Tub*

3953
15cm x 23cm x 7cm
Ctn 6



* Galvanised steel is not dishwasher safe and should not come into contact with food. Always line with greaseproof paper before adding food

Food service | Bell | Trays | Markers

Service Bell 3½"

3696
Ctn 100

- Steel Service Bell, ideal for kitchen food service or reception desks



Cutlery Trays

13" x 21"
Ctn 12

Grey **3759**
Black **3760**



Steak Markers - Pk 1000

Ctn 5

3331
Rare

3332
Medium Rare

3333
Medium

3334
Medium Well

3335
Well Done



Tab Grabbers |

Food service

Tab Grabbers

Ctn 2



NEW



3686
12"



3687
18"



3688
24"



3689
36"



3690
48"



*Ashbins
& ashtrays*

Ashbins & ashtrays

Powder Coated Ashbin
Wall Mounted

ASHBINPC
Ctn 6



Stainless Steel Ashbin
Wall Mounted

ASHBINSS
Ctn 6



4" Black Melamine Ashtray

3703
Ctn 20

Sold in multiples
of 10



7" Black Melamine Ashtray

3708
Ctn 12

Sold in multiples
of 10



3½" Stainless Steel Windproof Ashtray

3706P
Ctn 1

Sold in multiples
of 24



5¼" Black Melamine Windproof Ashtray

3707P
Ctn 8

Sold in multiples
of 6



Table top

Reserved

Menu Holders | *Table top*

Perspex A5 Menu Holder
(Angled)

3422
Ctn 80



Perspex A4 Menu Holder
(Angled)

3424
Ctn 60



Perspex A5 Menu Holder
(Vertical)

3423
Ctn 30



Perspex A4 Menu Holder
(Vertical)

3425
Ctn 30



Perspex Tent Type
Menu Holder

3426
Ctn 400



Table top | Numbers

Stainless Steel Table Nos.

Number Sets

Ctn 100

3467 Nos. 1-10 Set

3468 Nos. 11-20 Set

3469 Nos. 21-30 Set

3470 Nos. 31-40 Set

3461A Nos. 41-50 Set

3461B Nos. 51-60 Set

Individual Numbers

3460

Ctn 1



Plastic Table Nos.

Number Sets

Ctn 100

3442 Nos. 1-10 Set

3443 Nos. 11-20 Set

3444 Nos. 21-30 Set

3445 Nos. 31-40 Set

3446 Nos. 41-50 Set

3447 Nos. 51-60 Set

Individual Numbers

3451

Ctn 1

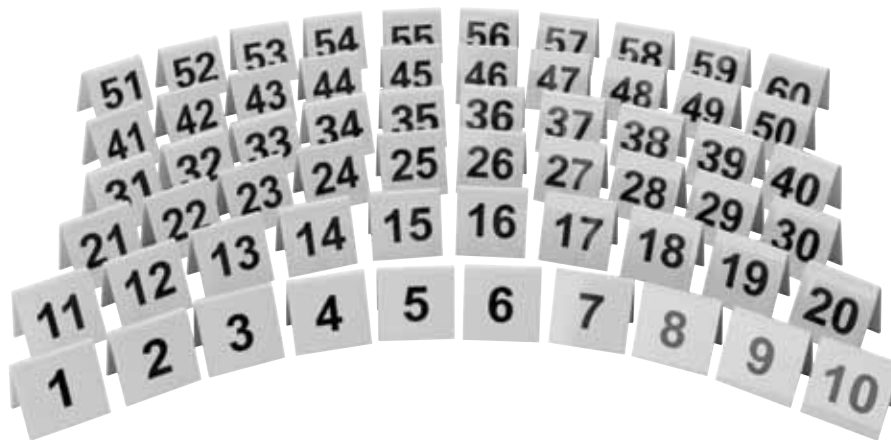

Information | *Table top*

Stainless Steel Tent Type Menu Holder

3457
Ctn 1



Stainless Steel Reserved

3454
Ctn 50



Stainless Steel No Smoking

3455
Ctn 50



Stainless Steel Beverages

Ctn 50



3465 Coffee
3463 Hot Water
3466 Milk
3464 Tea

Plastic Reserved

3453
Ctn 10



Plastic No Smoking

3452
Ctn 10



A close-up photograph of a white marker resting on a blackboard. The blackboard is covered in cursive handwriting in white chalk. The word "Henry" is visible at the top left, followed by "MENU" and "Lunch". The word "Display" is written in a larger, bold cursive font across the center of the image. Other faint words like "Dinner" and "LOVE" are also visible in the background.

Henry ✕ *Lunch*
MENU
Display
Dinner
LOVE

A-Boards | *Display*

Green Metal Sided A-Board

BB3 1100mm x 680mm

Ctn 1



- Traditional A-Board
- Legs manufactured from 38mm x 38mm box section steel, powder coated with UV stable polyester
- Precision engineered stay brackets manufactured from mild steel and yellow zinc plated

Reversible Curved Top, Oak Finish

RCAB01-O 800mm x 515mm

RCAB02-O 1100mm x 665mm

Ctn 1



- Reversible chalkboards, giving four usable faces
- Ideal for establishments offering different lunchtime & evening menus
- Replacement/extra boards available
- See page 128 for chalks and cleaner

Reversible Square Top, Oak Finish

RSAB01-O 800mm x 515mm

RSAB02-O 1100mm x 665mm

Ctn 1



Display | A-Board



Square Framed, Oak Finish

SAB01-O 800mm x 515mm

SAB02-O 1100mm x 665mm

SAB03-O 1400mm x 765mm

Ctn 1



■ See page 128 for chalks and cleaner

A-Board | Blackboards | *Display*

Curved Top, Oak Finish

CAB01-O 800mm x 515mm
CAB02-O 1100mm x 665mm
CAB03-O 1400mm x 765mm

Ctn 1



- Traditional wooden legged A-Board
- Precision engineered stay brackets manufactured from mild steel and yellow zinc plated

Framed Blackboard, Antique Pine Finish

FBB1-A 636mm x 486mm
FBB2-A 936mm x 636mm
FBB3-A 1236mm x 736mm

Ctn 1



- Superior quality chalkboards
- Available in oak and antique pine finishes
- Frames manufactured from American Redwood supplied from FSC approved sustainable sources
- Suitable for indoor use only
- See page 128 for chalks and cleaner

Framed Blackboard, Oak Finish

FBB1-O 636mm x 486mm
FBB2-O 936mm x 636mm
FBB3-O 1236mm x 736mm

Ctn 1



Display | Blackboards | Cork Board

Framed Blackboard, Dark Oak Finish

BB1 450mm x 600mm Ctn 10
BB2 600mm x 900mm Ctn 5



Framed Chalkboard, Natural Pine Finish

B628 400mm x 600mm Ctn 10



Framed Cork Notice Board Natural Pine Finish

B625 400mm x 600mm Ctn 10
B627 600mm x 800mm Ctn 10



- Suitable for indoor use only
- See page 128 for chalks and cleaner

Hand Held | *Display*

Hand Held Menu Board
Red Mahogany Base



A5
BB8
230mm x 148mm
Ctn 36



A4
BB9
320mm x 210mm
Ctn 24



A3
BB7
420mm x 297mm
Ctn 24

- Ideal for use on table tops and bars
- See Page 128 for chalks and cleaner

Display | Hand Held

Hand Held Menu Board
Natural Wood Base

320mm x 210mm



Grey
BB6GREY
Ctn 1



Cream
BB6CREAM
Ctn 1



Orange
BB6ORANGE
Ctn 1



Green
BB6GREEN
Ctn 1

- Ideal for use on table tops and bars
- See Page 128 for chalks and cleaner

Easels | *Display*

Floor Standing Easel and Blackboard, Oak Finish

EA03 1450mm x 740mm (900mm x 600mm blackboard) Ctn 1



- Locking bar prevents accidental collapse when open

Table/Bar Top Easel, Mahogany Finish

A4/A5 Easel

EA01 330mm x 220mm Ctn 12

A5 Easel Board, Foamex

BB10A 148mm x 210mm Ctn 50

A4 Easel Board, Foamex

BB10 210mm x 297mm Ctn 25



- Manufactured from Poplar sourced from FSC approved sustainable sources
- Will accommodate either A5 or A4 boards
- See page 128 for chalks and cleaner

Display | Chalk

6mm Chisel Tip White
Pk 5

3564
Ctn 1



6mm Chisel Tip Mixed
Colours Pk 5

3565
Ctn 1



White Chalk – Box 100

3576
Ctn 20



Coloured Chalk – Box 100

3577
Ctn 20



15mm Chisel Tip White
Pk 5

3566
Ctn 1



15mm Chisel Tip Mixed
Colours
Pk 5

3567
Ctn 1



Cyclone Chalkboard
Cleaning Solution

3909
Ctn 10



Blackboard Paint
250ml

3563
Ctn 6



Signage | *Display*

Law Signs

170mm x 110mm
Ctn 25

- Complete with double sided tape

125ml **B882**



125ml & 175ml **B883**



125ml & 250ml **B884**



35ml **B886**



25ml **B885**



Hours of Business Sign

B192
Ctn 100

- Complete with window suckers





*Skips, bins
& storage*

Skips | *Skips, bins & storage*

125L Capacity

3481B L 660mm x W 470mm x H 690mm (ext)
Ctn 1



130L Capacity

3482B L 600mm x W 455mm x H 795mm (ext)
Ctn 1



160L Capacity

3483B L 815mm x W 455mm x H 670mm (ext)
Ctn 1



160L Capacity

3485B L 970mm x W 360mm x H 670mm (ext)
Ctn 1



185L Capacity

3484B L 660mm x W 620mm x H 695mm (ext)
Ctn 1



Replacement Castors - Set of 4

3486
Ctn 1



Skips, bins & storage | Recycling

Grey Slim Recycling Bin 87L

3487

L 286mm x W 506mm x H 755mm

Ctn 6



Swing Lid for Recycling Bin

3488

Ctn 8



- Ideal for storing empty bottles
- Space saving design
- Spring-loaded closure

Glass Storage | *Skips, bins & storage*

L 500mm x W 345mm x H 165mm – Pk 5

3900
Ctn 5



- Holds 24 x 10oz High Ball or 10oz Nonic

L 500mm x W 345mm x H 200mm – Pk 5

3901
Ctn 5



- Holds 15 x 1 pint glass

Universal Lid
– Pk 5

3904
Ctn 20

L 500mm x W 345mm x H 200mm – Pk 5

3902
Ctn 5



- Holds 24 x 12oz Nonic or 12oz Slim Jim or Wine Glass

L 500mm x W 345mm x H 200mm – Pk 5

3903
Ctn 5



- Holds 35 x Champagne Flutes



First aid



What size is required?

Employers are required to make a risk assessment to decide what the hazard levels are and how many employees are involved in the area to be covered. You should use the guide below together with your risk assessment to decide on the size and placement of first aid kits in your workplace.

LOW HAZARD

e.g. shops, offices, libraries etc.

- **Less than 25 employees**
Small size kit
- **25-100 employees**
Medium size kit
- **More than 100 employees**
1 Large kit per 100 employees

HIGH HAZARD

e.g. light engineering and assembly work, food processing, warehousing, extensive work with dangerous machinery or sharp instruments, construction, chemical manufacture etc.

- **Less than 5 employees**
Small size kit
- **5-25 employees**
Medium size kit
- **More than 25 employees**
1 Large kit per 25 employees

Kits | Refills | *First aid*

Small BS Catering First Aid Kit

3718
Ctn 10



Medium BS Catering First Aid Kit

3719
Ctn 10



Large BS Catering First Aid Kit

3720
Ctn 5



Small BS Catering First Aid Kit Refill

3718R
Ctn 1



Medium BS Catering First Aid Kit Refill

3719R
Ctn 1



Large BS Catering First Aid Kit Refill

3720R
Ctn 1



First aid | Plasters

Blue Detectable Plasters - 75mm x 25mm
Food Hygiene - PK100

3702
Ctn 50



Blue Detectable Plaster - Assorted Sizes
Food Hygiene - PK120

3704
Ctn 50



Burns Treatment | *First aid*

Burns Kit

3712
Ctn 1



Burns Gel Bottle 125ml

3713
Ctn 6



Blue Hydrogel Burns Plasters - Two Sizes PK25

3715
Ctn 1



Burns Dressing 10cm x 10cm

3714
Ctn 10



Index

A					
A-Boards	121-123	Bottle Racks, Brackets & Stands	101-105	Collarless Quick Shot Pourer	50
Anti-Slip Tray Mats	79	Bottle Skips	131	Condiment Holders	65
Appetiser Serving	111	Brewery Nut	108	Coolers	
Aquaflow Pourer	48	Brush Glass Washer	62	Aluminium Bar Cooler Tub	85
Ashbins & Ashtrays	115	Bucket Stands	87	Bellagio Wine/Champagne Cooler	73
		Burns Kit & Treatment	137	Bolalto Wine Cooler	71
				Bolargo Wine/Champagne Cooler	71
B		C		Bollate Wine/Champagne Cooler	73
Bar Blades	82	Cap-On Pourer	48	Chrome & Plastic Wine Cooler	85
Bar Blade Holster	82	Cap Catcher	82-83	Ciro Wine/Champagne Cooler	74
Bar Blade Vinyl Coated	82	Cellar		Fresco Wine/Champagne Cooler	70
Bar Caddies	64	32oz Rubber Mallet	109	Galvanised Steel Beverage Tub	89
Bar Knife	36	38mm Cane Porous Spile	109	Obella Wine/Champagne Cooler	70
Bar Mats	56-57	58mm Hardwood Spile	109	Secchio Wine and Champagne Cooler	74
Bell	112	Brewery Nut	108	Stainless Steel Wine Cooler	85
Blackboards	123-124	Cask Taps	107	Taille Ice Bucket	69
Boston Cans		Hop Strainer	108	Copper Mugs	12
28oz Boston Can Stainless Steel	10	Hose Tail	108	Cork Board	124
Boston Can Black Vinyl Coated	22	Sparkler	109	Corks	96
Boston Can 28oz Stainless Steel	23	Tap Brush	109	Corkscrews	81
Mezclar 18oz Boston Can Stainless Steel	10	Turn Down Spout	108	Cutlery Trays	112
Mezclar 18oz Can & 28oz Boston Can Set	10	Chalkboard Cleaning Solution	128		
Mezclar Boston Can Black Floral	11	Chalk	128	D	
Mezclar Boston Can Copper Plated	9	Champagne Bucket/Coolers	68-75, 86	Drip Trays	
Mezclar Boston Can Pink Floral	11	Champagne Stopper	83	Aluminium Effect Drip Tray	59
Mini 16oz Boston Can Stainless Steel	23	Cheque Spindle	67	Brass Effect Drip Tray	59
Orange Powder Coated Boston Can	22	Chopping Board	36	Stainless Steel Drip Tray	59
White Powder Coated Boston Can	22	Chrome Freeflow Pourer	44	Stainless Steel Round Drip Tray	59
Yellow Powder Coated Boston Can	22	Cocktail Parasols	41	Wooden Drip Tray	58
Boston Glass	23	Cocktail Sticks	41		
Bottle Openers, Catchers, Sealers	81-83	Coco Lopez Cream of Coconut	37		

E		I		L	
Easels	127	Ice		Law Signs	129
Euro Adapter	101	6 Section Red Silicone Ice Mould	33	Lemon & Lime Wedger	63
F		7" Stainless Steel Ice Tongs	88	Liquid Chalks	128
Fastflow Pourer Stainless Steel	43	10 litre Plastic Ice Bucket	88	M	
First Aid Kits	135	15 Section Blue Silicone Ice Mould	33	Menu Holder	117, 119
Flair Bottle	26	Barrel End Ice Tub Wood Grain	88	Metrix SL Spirit Measure	92
Floor Mats	55	Half Barrel End Ice Tub Wood Grain	88	Mexican Elbow – Lemon/Lime Squeezer	37
Freeflow Plastic Pourer	48	Ice Chipper	32	Mezclar	
Freeflow Pourer Stainless Steel	43	Ice Crusher	36	Mezclar 18oz Boston Can Stainless Steel	10
Freeflow Quick Shot Pourer – Clear	49	Ice Pick	32	Mezclar 18oz Can & 28oz Boston Can Set	10
Freepour Bottle™	53	Round Ice Bucket – Black	88	Mezclar Art Deco Shaker Copper Plated	6
G		Silicone Ice Ball Mould	35	Mezclar Art Deco Shaker Stainless Steel	6
Galvanised Serving Bucket, Tub	111	Silicone Ice Shot Glass Mould	35	Mezclar Banded Jigger Copper Plated	18
Garnish Tweezers	31	Square Ice Bucket – Black	88	Mezclar Banded Jigger Stainless Steel	18
Glass		Taille Ice Bucket	69	Mezclar Boston Can Black Floral	11
3 Brush Glass Washer	62	Ice Buckets	69, 86, 88	Mezclar Boston Can Copper Plated	9
3 Part Glass Rimmer/Spare Pad	36	Identi-clip	99	Mezclar Boston Can Pink Floral	11
5 Brush Glass Washer	62	J		Mezclar Cocktail Spoon with Fork	16
Boston Glass	23	Jiggers		Mezclar Collinson Spoon	16
Carrier	62	Classic UK 25ml/50ml CE Marked Jigger	97	Mezclar French Shaker Copper Plated	7
Hangers	66	Mezclar Banded Jigger Copper Plated	18	Mezclar French Shaker Stainless Steel	7
Mats/Tile	60	Mezclar Banded Jigger Stainless Steel	18	Mezclar Hudson Spoon	16
Mixing Glass	15	Mezclar Preciso Multi Measure Jigger	19	Mezclar Jug Stainless Steel	11
Storage	133	Professional 25ml/50ml Cocktail Jigger	97	Mezclar Julep Cup	14
Grater	31	Jug	11	Mezclar Mixing Glass	15
H		Julep Cup	14	Mezclar Moscow Mule Mugs	12
Hand Held Menu Board	125-126	Julep Strainers	29	Mezclar Piccolo Mini Shaker	8
Hop Strainer	108			Mezclar Preciso Multi Measure Jigger	19
Hose Tail	108			Mezclar Strainer Copper Plated	18
Hours of Business Sign	129			Mezclar Strainer Stainless Steel	18

Index

Mixing Glass	15	Collarless Quick Shot Pourer - Clear	50	Rubber Interlocking Floor Mat	55
Moscow Mule Mugs	12	Fastflow Pourer Stainless Steel	43	Rubber Mallet	109
Muddlers		Freeflow Plastic Pourer	48		
Large Wooden Muddler 13"	25	Freeflow Pourer Stainless Steel	43	S	
Plastic Muddler 8½"	25	Freeflow Quick Shot Pourer - Clear	49	Save & Pour Professional Quart	52
Stainless Steel & Plastic Muddler 8¼"	25	Freepour Bottle™	53	Save & Pour Quart	51
Wooden Muddler 8"	24	Pourer Cap	43	Scoops	
Wooden Muddler 10"	24	Pro Pour	43	Aluminium Ice Scoops	38
		Quick Shot Pourer	49	7oz Plastic Drainer Scoop	38
N		Save & Pour Professional Quart	52	Service Bell	112
Non-Slip Trays	77, 78	Save & Pour Quart	51	Serving Bucket	111
Nutmeg Grater	31	Sure Shot Pourer	50	Serving Tub	111
		TD105-30	44	Shakers	
O		Preparation		DeLuxe Cocktail Shaker Stainless Steel	21
Openers & Sealers	81-83	Bar Knife	36	Mezclar Art Deco Shaker Copper Plated	6
		Chopping Board	36	Mezclar Art Deco Shaker Stainless Steel	6
		Garnish Tweezers	31	Mezclar French Shaker Copper Plated	7
P		Lemon & Lime Wedger	63	Mezclar French Shaker Stainless Steel	7
Perspex Menu Holders	117	Mexican Elbow - Lemon/Lime Squeezer	37	Mezclar Piccolo Mini Shaker Stainless Steel	8
Picks		Nutmeg Grater	31	Regular Cocktail Shaker Stainless Steel	21
3½" Assorted Prism Pick	40	Pineapple Slicer & Wedger	37	Shelf Brackets	101
3½" Black Prism Pick	40	Zester and Canale Cutter	31	Shelf Liner	61
3½" Black Swirl Pick	41			Shot Clip	99
3½" Clear Prism Pick	40	Q		Shot Rails	100
3½" Clear Swirl Pick	41	Quick Shot Pourers	49-50	Signage	129
3½" Red Prism Pick	40			Signature	
Pineapple Slicer & Wedger	37	R		Bellagio Wine/Champagne Cooler	73
Plasters	136	Recycling Bin	132	Bolalto Wine Cooler	71
Pourer Cap	43	Re-Sealers	82	Bolargo Wine/Champagne Cooler	71
Pourers		Reserved Sign	119	Bollate Wine/Champagne Cooler	73
Aquaflow Pourer	48	Rotary Bottle Stands	104-105	Ciro Wine/Champagne Cooler	74
Cap-On Pourer	48	Rubber Bevelled Edge Floor Mat	55	Classique Wine/Champagne Bucket & Stand	75
Chrome Freeflow Pourer	44				

Index

Fresco Wine/Champagne Cooler	70	Stirrers	Tip Trays	67
Obella Wine/Champagne Cooler	70	6½" Black Swirl Stirrer	Tom Dyer	44, 47
Secchio Wine and Champagne Cooler	74	6½" Clear Swirl Stirrer	Toothpicks - Paper Wrapped Wooden	41
Taille Ice Bucket	69	6" Disc Stirrers	Trays	77, 78, 112
Voltre Wine/Champagne Bucket & Stand	75	6" Flat Ball Stirrers - Black	Tub Coolers	88-89
Skips	131	6" Flat Ball Stirrers - Clear	Turn Down Spout	108
Sparkler	109	6" Rod Stirrers - Clear	Tweezers	31
Speed Rail	37	7" Assorted Prism Stirrer	V	
Spiles	109	7" Black Prism Stirrer	Vacu Vin Sealers	83
Spirit Measure Cleaner	96	7" Clear Prism Stirrer	Vacu Vin Wine Pump	83
Spirit Measures		7" Disc Stirrer	W	
Metrix SL Spirit Measure	92	Strainers	Wall & Shelf Brackets	101
Solo Aniseed Measure	95	Fine Mesh Strainer	Water Jug Stainless Steel	11
Solo Classical Chrome Measures	94	Hawthorne Strainer - 2 Ear	Wedger	63
Solo Classical Measure	93	Hawthorne Strainer - 4 Ear	Wine Bottle Re-Sealers	82
Solo Counter Measures	95	Julep Strainers	Wine Cooler	70-75, 85
Solo Professional Measures	94	Mezclar Strainer Copper Plated	Wooden Drip Tray	58
Solo Wine Measures	95	Mezclar Strainer Stainless Steel	Z	
Spirit Measure Cleaner	96	Professional Strainer	Zester and Canale Cutter	31
Vogue Spirit Measure	91	Sure Shot Pourer		
Spoons		T		
Cocktail Spoon	30	Tab Grabbers		
Cocktail Spoon with Masher	30	Table Numbers		
Mezclar Cocktail Spoon with Fork	16	Table Signs		
Mezclar Collinson Spoon	16	Tap Brush		
Mezclar Hudson Spoon	16	Taps		
Professional Mixing Spoon	30	TD105-30		
Stand Coolers	75	Thimble Measures		
Steak Markers	112	Tin on Tin		

Terms & conditions

These Conditions of Sale shall override any terms or conditions proposed or stipulated by the buyer unless agreed by us. Any order placed or goods accepted by the Buyer shall signify acceptance of these Conditions of Sale.

1. Quantities and Quotations

- a** Prices and charges quoted are based on costs prevailing at the date of quotation. If those costs increase before the date of delivery we reserve the right to amend the prices and/or charges accordingly.
- b** We reserve the right to refuse the acceptance of the Buyer of a quotation unless such quotation is stated to be open for a specific period and is not withdrawn within such period.
- c** Prices quoted are for stipulated quantities and delivery rates only and do not necessarily hold good for other quantities or other delivery rates.
- d** We reserve the right to deliver an excess or deficiency of up to TEN percent on specially printed or commissioned items and the total contract price will accordingly be adjusted.

2. Orders

- a** We reserve the right to accept or refuse orders.
- b** All orders of £100 and over will be delivered carriage paid to one UK mainland address.
- c** All orders below £100 will be subject to a £8.95 carriage charge, delivered to one UK mainland address.
- d** Our minimum order value is £50
- e** We reserve the right (without prejudice to any other remedy) to cancel or suspend delivery of all or part of any order.

3. United Kingdom Sales

- a** Unless otherwise stated in writing all prices are ex-works ruling at the date of despatch, exclusive of packing for orders under £100. VAT, duties or other Government imposts.
- b** Invoices are payable net within THIRTY days of the date of the invoice. Without prejudice to any other rights that we may have we reserve the right to charge TWO percent per calendar month on any unpaid balance that remains outstanding.

- c** Where stands are provided on loan for merchandising they must only be used for the merchandising of our goods in our packaging.

4. Export

- a** Unless otherwise agreed in writing all prices are ex-works ruling at the date of despatch inclusive of packing but exclusive of VAT, duties or other Government imposts.
- b** Unless otherwise agreed by us, payment will be by Irrevocable Letter of Credit confirmed on a London Clearing Bank arranged for payment in full against shipping documents, airwaybill, air parcel post receipt etc. All bank charges are payable by the Buyer.
- c** The Buyer shall in good time and at his expense procure any necessary import permit and if required by us to produce to us evidence of this prior to shipment.
- d** Our responsibility for goods shall cease immediately the goods are placed on board ship from which time the risk of any loss or damage to the goods from whatever cause arising shall be borne by the Buyer and we shall be under no obligation to give to the Buyer the Notice specified in Section 32 (3) of the Sale of Goods Act 1893.
- e** We shall be entitled to demand proof that the goods have been exported and to charge extra prices and claim damages when proof is not forthcoming that the goods have been exported in the condition as delivered by us.

5. Additional Charges

The Buyer shall pay

- a** An additional price in respect of any alteration in design or specification made at the Buyer's request including the cost of all artwork, blocks, dies and other tools specially bought or made for the purpose of the order. Such artwork, blocks, dies and tools shall however be and remain our sole property.

- b** All storage charges including insurance and other associated costs that may be incurred by us as a result of the Buyer refusing or being unable to take delivery of the goods or by delaying delivery of the goods in not giving us sufficient instructions to enable us to deliver the goods. This risk of deterioration and damage to the goods so sorted shall lie with the Buyer.

6. Default

If the Buyer makes default in any payment on the due date (time being of the essence) or is otherwise in breach of any of these conditions, or if (being an individual) he commits an act of bankruptcy or had a receiving order made against him or (being a company) enters into liquidation (whether compulsory or voluntary other than for the purpose of amalgamation or reconstruction) or calls a meeting of creditors under Section 588 of the Companies Act 1985 or has a receiver or manager appointed of the whole or any part of its business or undertaking, or if distress of execution is levied or threatened upon any of the Buyer's property, then in any such case (and without prejudice to any other rights we may have) we shall be entitled to suspend all further deliveries to the Buyer until the default is made good and/or to refuse to deliver any further goods to the Buyer and to re-sell any further goods ordered by the Buyer notwithstanding that they may have been paid for in whole or in part.

7. Appropriation

We shall be entitled to appropriate any payment made by the Buyer towards such of the Buyer's liabilities to us as we shall in our discretion think fit notwithstanding anything to the contrary by the Buyer in relation to such payment and the said power of appropriation may be exercised by us either at the time such payment is made or at any time thereafter.

Terms & conditions

8. Lien

In the event of the Buyer's insolvency we shall be entitled (in addition to any lien arising by law) to a general lien on all of the Buyer's goods in our possession (although the same or some of them may have been paid for) for any money due either in respect of such goods or in respect of any general or particular balance or other money due from the Buyer to us, whether under the same or any other order.

9. Ownership and Risk

- a As from the time of delivery of the goods to the Buyer the risk of any loss or damage to the goods from whatsoever cause arising shall be borne by the Buyer.
- b Upon payment in full as aforesaid the property in the goods shall pass to the Buyer but until such time the goods shall remain our sole property and the Buyer shall be a mere bailee thereof and shall at all times keep them in his possession and control and will not sell or otherwise dispose of or deal with them. In the event that the Buyer sells the goods to any third party, the proceeds of sale of such goods shall be retained in trust by the Buyer for us in a separate account created for that purpose, and dealt with promptly according to our instructions.
- c Until the property in the goods shall have passed to the Buyer we shall be entitled at any time to repossess and for that purpose we and our servants and agents shall be entitled to enter upon any property in which the goods are situated (notwithstanding the termination of the contract for whatever reason).

10. Limitation of Liability

- a We shall be relieved of all liability for obligations incurred to the Buyer whenever, and to the extent to which the fulfilment of such obligation is prevented, frustrated or impeded directly or indirectly in consequent of any statute, rules, regulations, orders or requisitions issued by any government department, council or other duly constituted authority or be reason of any government action, industrial action, trade

dispute, fire, flood, storm breakdown of plant, accident, theft, riot, civil commotion, war, national emergency, act of God, force majeure, inevitable accident or any other cause beyond our control. In the event of the occurrence of any such circumstances we shall be entitled to cancel the contract with the Buyer by giving notice in writing to him and until we cancel the contract to extend the time of its performance by a period equivalent to that during which its performance has been prevented by any of the said from the cancellation or suspension. Where delivery is by installments each delivery shall be considered as a separate order and a failure of any delivery shall not vitiate the order as to the others.

- b All times quoted for dispatch are to be treated as estimates only and we should not be liable to any manner whatsoever for failure to despatch within such time.
- c Where we are responsible for delivery we shall not be liable for damage to the goods in transit unless such loss or damage is proved to our satisfaction to be due to faulty packaging. No claim will be considered unless notified to us in writing within three days from delivery date.
- d Other than the death of or injury to any person resulting from our negligence we shall not be liable to the Buyer or to any third party in any circumstances whatsoever.
 - i) for any consequential loss or damage of any kind directly or indirectly attributable to any faults or defects in the goods, or
 - ii) for any damage or injury caused by any faults or defects in the goods, or
 - iii) for any consequential loss or damage of any kind directly or indirectly attributable to any negligence or wilful acts of our employees or agents, or
 - iv) for any damage to property caused by the negligence or wilful acts of any of our employees or agents.
- e The Buyer shall indemnify us against all claims and demands made upon us for any consequential loss or damage.

11. Representations

No representation or statement not expressly contained in these Conditions of Sale or incorporated hereby by reference to a written document duly authorised by us shall be binding upon us as a warranty or otherwise, nor shall anything be implied from any such representation or statement.

12. Notices

- a Each notice to be given hereunder shall be in writing addressed to the other party's main business address or in either case to such other address as one party shall notify in writing to the other for this purpose.
- b Any Notice shall be deemed given either if left at the proper address, if delivered by hand during normal business hours, or forty eight hours after having been posted by first-class prepaid post in an envelope addressed to the proper address and on the business day next following the day of transmission if transmitted by telex or facsimile.

13. Latitude

No relaxation, forbearance, delay or indulgence by us in enforcing any of the terms and conditions of these Conditions of Sale for the granting of time to the Buyer or otherwise shall prejudice, affect or restrict our rights and powers hereunder nor shall any waiver by us of any breach hereof operate as a waiver of any subsequent or any continuing breach hereof.

14. Law

These Conditions of Sale and all matters pertaining thereto shall be governed by English law, and the English Courts shall have jurisdiction in relation thereto.

15. Headings

The headings do not form part of these Conditions of Sale and should not be taken into account in their interpretation.

E & OE





Beaumont™ 